

Pump Model CPS 200-150-290

Speed 1450rpm

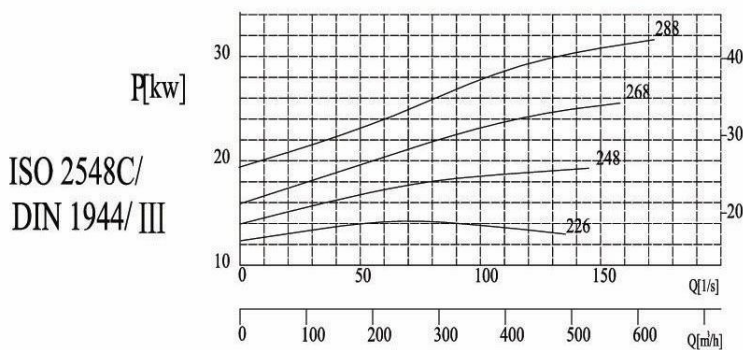

ISO 2548C/
DIN 1944/ III

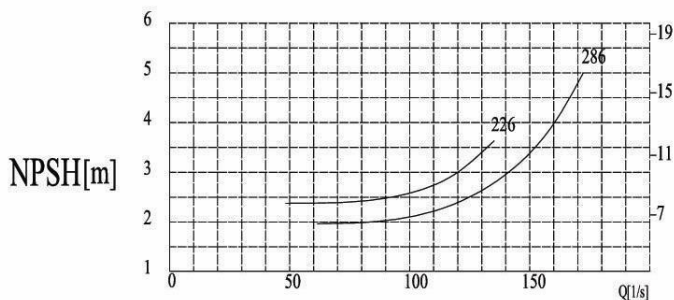
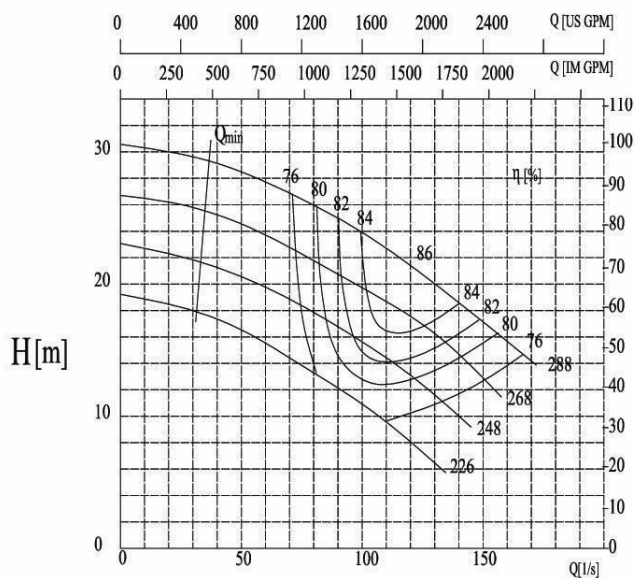
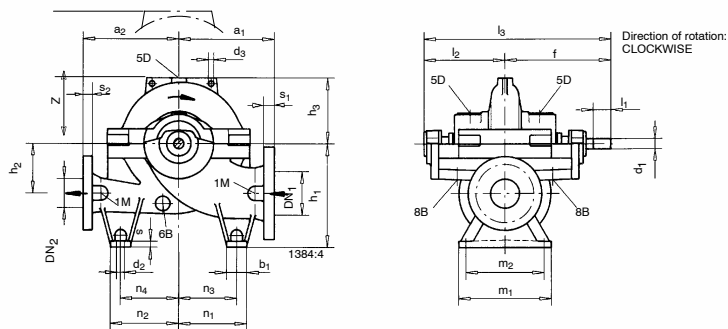

Pump Size	FLANGE DIMENSIONS				PUMP DIMENSIONS									
	DN1	DN2	s1	s2	a1	a2	d3	f	h1	h2	h3	l2	l3	z
CPS 200-150-290	200	150	41	37	400	400	19	515	400	200	245	366	881	490
	FOOT DIMENSIONS					SHAFT					PUMP WEIGHT			
	b1	d2	m1	m2	n1	n2	n3	n4	s	d1	L1	(kg)		
	70	18	390	340	260	260	225	225	20	45	100	350		